



## PC364T-60-4

### CONVERTER

DESIGNED FOR USE WITH ROTARY PHASE CONVERTER UNITS

TOTALLY ENCLOSED FAN COOLED

SPIKE RESISTANT WIRE (2200V PEAK VOLTAGE SPIKE RATING)

Factory Certified for T2B Class I, Division II, Groups A,B,C & D and Class II, Division II, Groups F & G

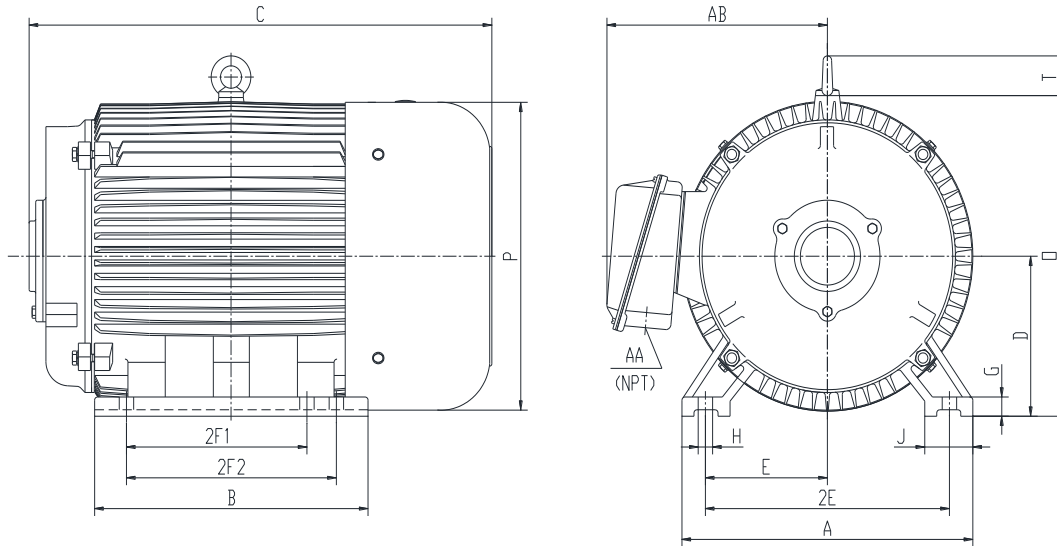

### DIMENSIONS

HP	RPM	Frame	MOUNTING													
			A	B	C	D	G	H	J	E	2E	2F1	2F2	O	P	T
60	1800	364T	17.1	14.4	26.3	9	1.15	0.66	2.95	7	14	11.25	NA	18.1	17.6	2.6

Conduit Box		Bearings		Mount
AA	AB	DE	ODE	
3	14.6	6313	6313	F1

**BEARING LUBRICATION:** The bearings come lubricated with Mobil Polyrex EM Polyurea Grease. It is recommended that you add some additional lubrication when the motor is installed.

Three options (brands) for suitable lubrication include, but are not limited to, the following:

- 1.) Mobil Polyrex EM
- 2.) Citco Polyurea MP
- 3.) Conoco Phillips Polytac EP





## PC364T-60-4

### CONVERTER

DESIGNED FOR USE WITH ROTARY PHASE CONVERTER UNITS

TOTALLY ENCLOSED FAN COOLED

SPIKE RESISTANT WIRE (2200V PEAK VOLTAGE SPIKE RATING)





Factory Certified for T2B Class I, Division II, Groups A,B,C & D and Class II, Division II, Groups F & G

### PERFORMANCE DATA

HP	RPM	Frame	Voltage	Frequency (Hz)	Full Load S.F.	Insulation Class	NEMA Design	Slip (%)	NEMA Code	Enclosure Type	IP Rating	Max. Ambient
60	1780	364T	208-230/460	60	1.15	F	B	1.1	G	TEFC	55	40 °C

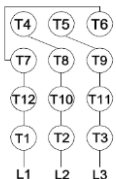
Amps (460V)		Efficiency (%)		Power Factor	Torque (ft-lb)			DE Bearing	ODE Bearing	Connection	Weight (lbs.)
FLA	LRA	NOM.	MIN.	100%	FLT	LRT %	BDT %				
70	435	93.6	92.4	0.88	177.6	190	270	6313	6313	12 Lead 2Δ/Δ	828

### NAME PLATE

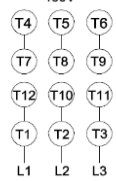
 <b>ROTARY PHASE CONVERTER</b> INVERTER DUTY 20:1 VT; 10:1 CT      Hernando, MS 38632										<b>CONNECTION DIAGRAMS</b> 208-230V 													
CAT NO.		PC364T-60-4				FRAME		364T			WT/LBS		828										
HZ		60		S.F.		1.15		HZ		50		S.F.		1.0		ENCL		TEFC		IP		55	
HP		60		RPM		1800		HP		60		RPM		1500		DUTY		CONT		DES		B	
VOLTS				208-230/460				VOLTS				190/380				AMB		40 °C		INS		F	
AMPS				150-140/70				AMPS				168/84				BRG DE/ODE		6313/6313					
CODE		G		P.F.		0.88		CODE		F		P.F.		0.88		LUB: Mobil Polyrex EM							
EFF		93.6		MIN		92.4		EFF		92.0		MIN		90.8		SER NO							
				AC INDUCTION CONVERTER												460V 							

### APPLICATIONS:

Specifically designed for use as the converter component for rotary phase converters.